

# GSM-AUTO

## GSM Controller User manual



### INDEX

Description.....	2
Preparing the SIM card.....	3
Installation.....	4
Example connections.....	5
Programming commands.....	7
Quick reference of programming commands .....	12
Programming examples.....	13
Troubleshooting.....	14

Thank you for purchasing our product. Please read this manual before starting to install the GSM-AUTO. If you are unsure how to connect to the device you wish to control refer to a qualified person

## GSM-AUTO CONTROLLER

### IMPORTANT!

Please read through this instruction manual before you start to install and program the GSM-AUTO.

**If you are unsure how to connect the device you wish to control refer to a qualified person.**

### Description

The GSM-AUTO is a wireless remote control on/off switch that connects to the GSM cell phone network.

It has 2 independent relay switches, these can be programmed to switch on or off for a pre-determined length of time whenever the GSM-AUTO is called. The GSM-AUTO will recognise an authorised telephone number calling it and action the call without answering. Therefore, there are no call charges incurred when calling it.

The relay switches can also be temporarily or permanently switched on or off by sending the GSM-AUTO a text message command.

### Requirements

The GSM-AUTO requires a 12 volt DC power supply capable of providing a minimum current of 500mA, typical current consumption is 50mA

An active mobile phone SIM card with sufficient credit to send confirmation text messages when programming the GSM-AUTO

GSM-AUTO SPECIFICATIONS	
Operating Voltage	12 volts dc
Operating Current	Maximum 500mA, typically 55mA
Relay Contacts	2 x Normally Open and Normally Closed contacts maximum switching capacity 10 amps @ 230V ac per relay
GSM Frequency MHz	GSM-850, GSM-900, GSM-1800, GSM-1900
Humidity	Less Than 80% RH
Operating Temperature	-20°C to 55°C
Physical size	130 x 100 x 50 mm
Protection	IP65
Approvals	C.E

## Preparing the SIM card

All new SIM cards have to be registered with the network provider before they can be used, usually by calling the network provider or registering on their website please refer to the instructions supplied with your SIM card.

During the registration procedure a confirmation code or text message is usually sent to the SIM cards telephone number, to be able to read and react to the message you will need to insert the SIM card into an unlocked mobile phone.

After successfully registering the SIM card, ensure there is sufficient credit on the card for programming confirmation texts to be sent from the GSM-AUTO unit.

You **MUST** ensure that the PIN request is disabled from the SIM card before inserting it into the GSM-AUTO. **If you do not disable the PIN request the GSM-AUTO will not work.** If the PIN request is not disabled and the unit is switched on more than 3 times you will have to reset the PIN using the PUK code which will have to be obtained from the service provider.

To check the PIN request status of your SIM card, place the card in an unlocked mobile phone, switch the phone on. If you are able to make calls without entering a PIN number the PIN request is disabled. If a PIN number is requested refer to the instructions supplied with the SIM card and then look through the phones options for the 'disable PIN request' and disable it.

You **MUST** disable any voicemail that is set up on the SIM card, the codes shown below are for UK networks only, please refer to your network operator if outside the UK

Vodafone: 1210 >Send - you will hear 'order is accepted and confirmed'

O2 - Call 1760 >Send - you will hear 'order is accepted and confirmed'

T-Mobile - Call 222 and follow instructions

Orange - Call 450 and follow instructions

The SIM card is now ready to use

We recommend that if you are using a 'pay as you go' (PAYG) SIM card that you choose to automatically 'Top-Up' when the cards credit falls below a certain limit please contact your network provider or visit their website for more details.

Most but not all PAYG SIM cards will be de-activated by the network if not used to make an outgoing voice call or send an SMS text message within a specific period. To prevent this simply send the GSM-AUTO a txt command, it will reply by text message, do this once a month to keep the SIM card active.

## Installation

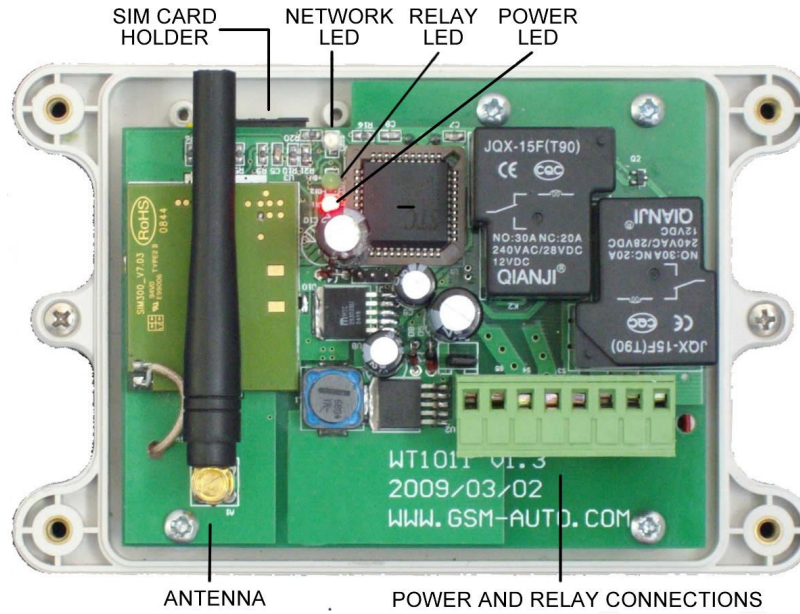

Insert the SIM card, to access the SIM card carrier gently push the button adjacent to it, insert the SIM card and carefully close the carrier.

Connect a 12 volt DC power supply to terminals 1 & 2 ensuring positive is connected to terminal 1, switch on the power supply, the red power LED will light indicating power is present, the blue network LED indicator will initially flash quickly, once logged onto the network it will flash more slowly approximately once every 3 to 4 seconds.

It is recommended that the GSM-AUTO be programmed to operate as required before final installation.

### Connection details

**If you are unsure how to connect the device you wish to control refer to a qualified person**

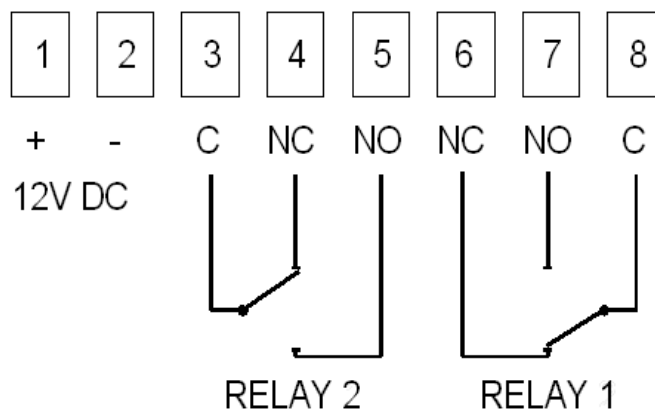

## Example connections

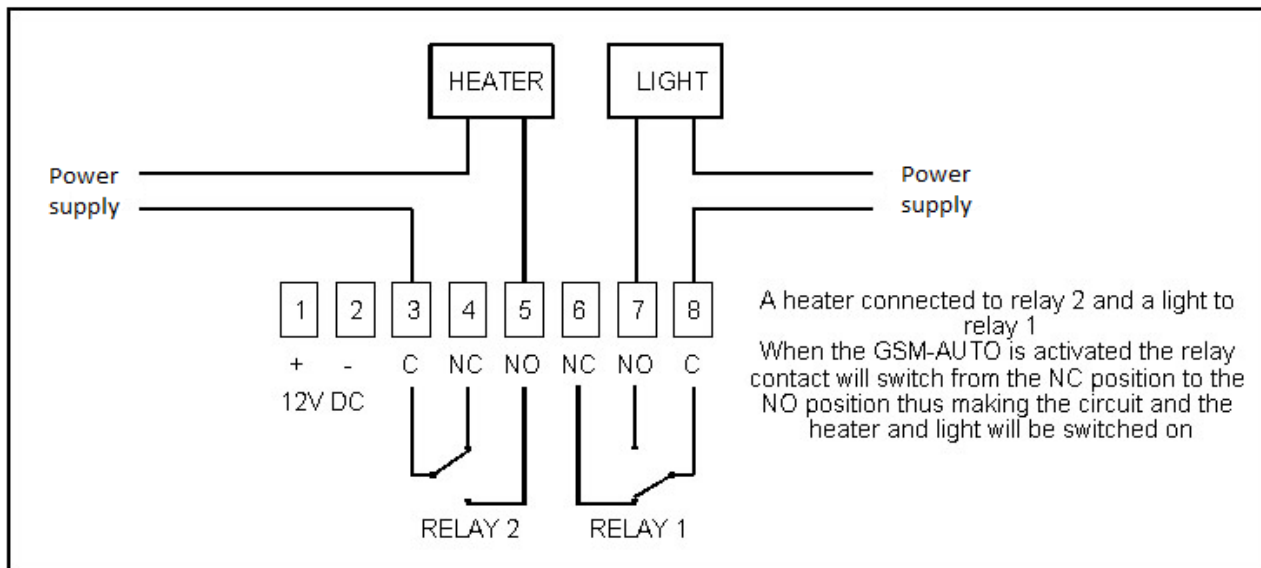
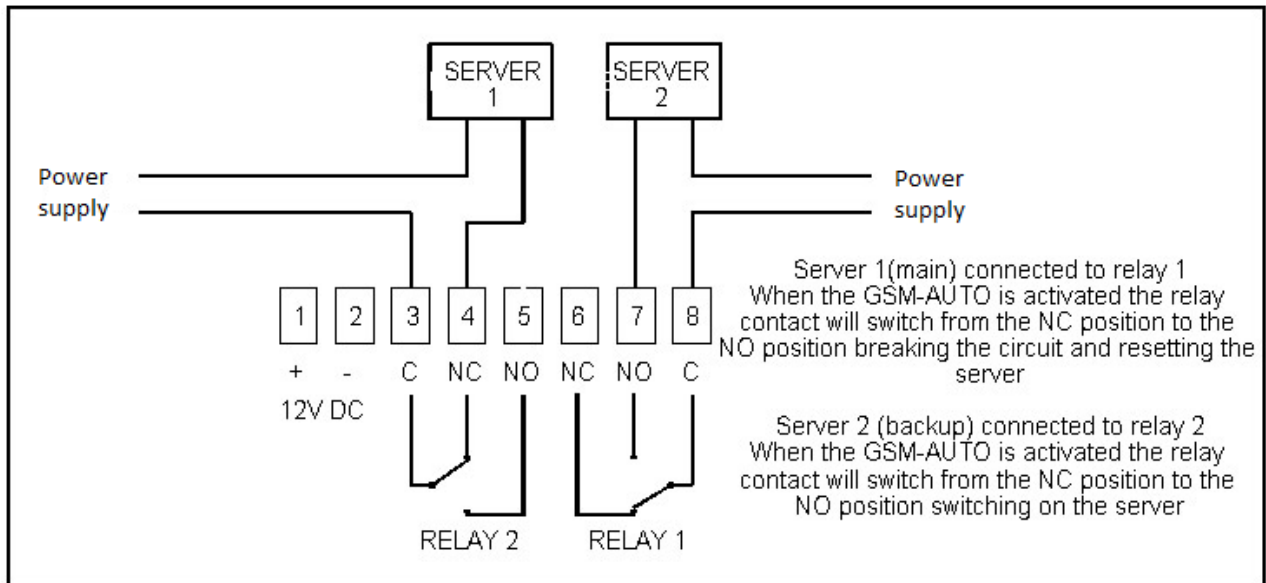

## Default settings

The default settings are, open access mode\*, when the GSM-AUTO is called, relay 1 switches on for 2 seconds, 2 seconds later relay 2 switches on for 2 seconds, the default password is 123456

\* A call from any telephone number will activate the GSM-AUTO

## Programming the GSM-AUTO

The GSM-Auto is programmed by sending it SMS text commands, these are sent to the telephone number of the SIM card installed in the GSM-AUTO. The password command must pre-fix all SMS text commands it is recommended the default password be changed.

Remember that all SMS text commands must always be sent using **CAPITAL LETTERS**

**DO NOT** add spaces or any other characters

## #PWD

### Password

This command must always pre-fix any SMS text commands sent to the unit.

**#PWDXXXXXX** where xxxxxx is the six digit password.

The units default password is 123456 so initially **#PWD123456** is entered before the command, of course when you change the password you will pre-fix all commands with the new password

## #CAP

### Changing the Password

To change the password of the unit you use the **#CAP** Command and to change the password from the default 123456 to 121212 you would send the following SMS text message to the unit.

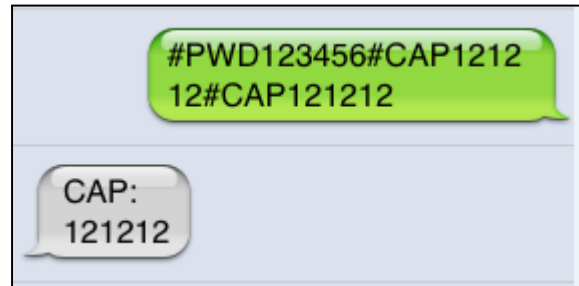

**#PWD123456#CAP121212#CAP121212**

You will receive the following confirmation from the unit **CAP:121212**

**IMPORTANT Please make a note of your new password, if you lose or forget the password you will not be able to access the unit**

**We have now changed the password to 121212 and will use this in the following examples**

## #CSQ

### Check the signal strength

This command is useful to see what the GSM network signal strength is at the location of the unit, it will report the signal strength in the range 0 to 31, a minimum of 5 is required. If it is below 5 then it is advised to use an external antenna.

To check the signal strength you would send the following SMS text message to the unit.

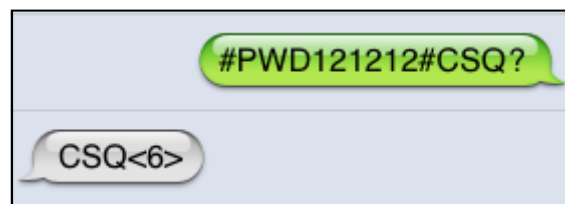

**#PWD121212#CSQ?**

You will receive the following similar confirmation from the unit **CSQ<6>**

## #TEL

### Administrator List

This is the command that allows you to add or remove the administrator telephone numbers that will receive text messages from the unit when the relays are switched on or off using the **#RLY** and **#RLOP** commands.

**If you wish to receive confirmation text messages that the relays have been switched on or off you must enter your telephone number into the Administrator list.**

## #TEL Administrator List—continued

Up to 8 Administrator numbers can be in the list and the numbers can contain up to 16 digits. If an administrator wishes to receive text messages whilst abroad prefix the number with the country code for example if a UK number +447827829595

To add 07827829595 to the administrator list you would send the following SMS text message to the unit.

### #PWD121212#TEL1=07827829595

You will receive the following confirmation from the unit **TEL1=07827829595**

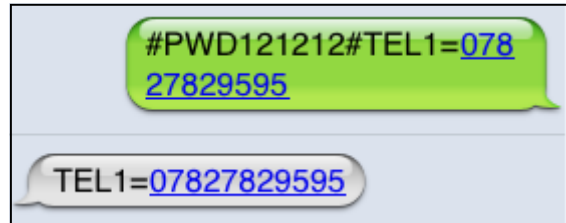

To check all the administrator number in the list you would send the following S.M.S text message to the unit.

### #PWD121212#TEL?

You will receive the following similar confirmation from the unit

**TEL1:07827829595**  
**TEL2:**  
**TEL3:**

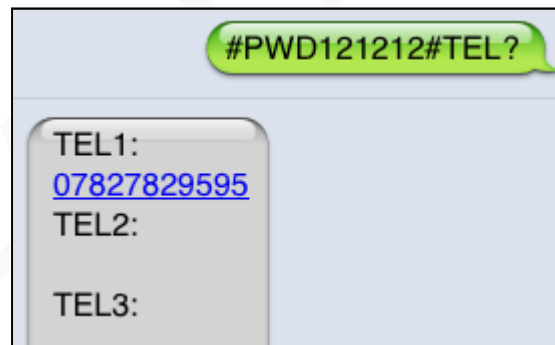

## #RERN

This is the command that allows you to enable, disable and check the status of the administrator list, these are the numbers that will receive text alerts.

For example to allow only the first administrator in the list to receive text alerts, you would send the follow SMS text command to the unit.

Where 1 enables the first position in the administrator list, and 0 (zero) disables the last 7 positions in the list.

### #PWD121212#RERN=10000000

You will receive the following confirmation from the unit **RERN:10000000**

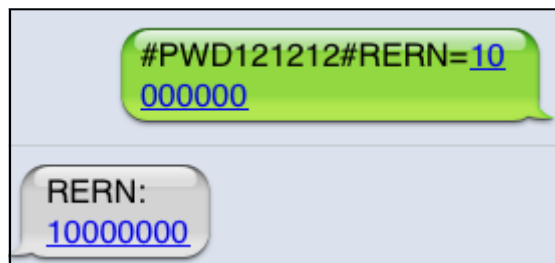

To check the status of the RERN list you would send the following S.M.S text message to the unit **#PWD121212#RER?**

You will receive the following similar confirmation from the unit **RERN:10000000**

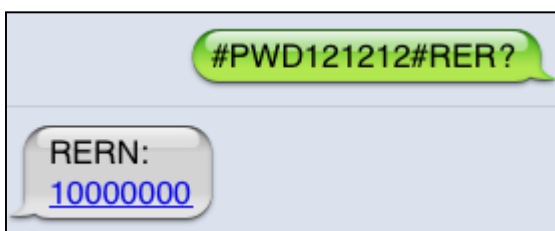



## #WHL White List

This is the command for adding to the white list authorised telephone numbers that can activate the unit.

By default the unit is set to open access mode and will be activated when it receives a call from any telephone number. When the authorised numbers have been added to the white list the unit should be set to secure access mode using the **#ACM2** command.

To add the number 07827829595 to the white list in position 1, you would send the following SMS text message to the unit. Note only enter the last 8 digits as shown.

**#PWD121212#WHL001=27829595**

You will receive the following confirmation from the unit **WHL001:27829595**

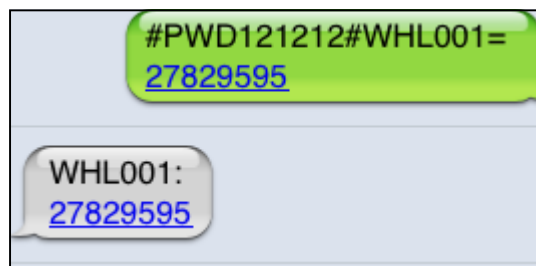

This is the first number in the White list and number 2 is sent as **#WHL002=** and so on up to a maximum of 500 numbers.

### Checking a number in the white list

To check the number in a position on the white list, for example position 001 you would send the following SMS text message to the unit.

**#PWD123456#WHL001?**

You will receive the following confirmation from the unit **WHL001:27829595**

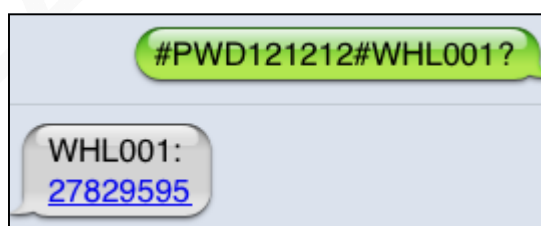

### Erasing a number in the white list

To erase a number in the white list you would send the following SMS text message to the unit.

**#PWD121212#WHL001D**

You will receive the following confirmation from the unit **WHL001-OK**

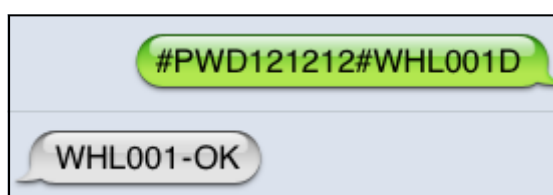

## #ACM Security Access Mode

This command enables access security mode so only the numbers programmed into the white list can activate the unit and you would send the following SMS text message to the unit.

**#PWD121212#ACM2**

You will receive the following confirmation from the unit **ACM-ON**

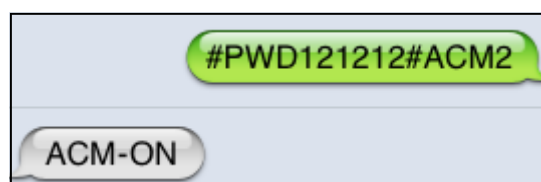



## #ACM Security Access Mode—continued

To turn off the security access mode you would send the following SMS text message to the unit **#PWD121212#ACM0** You will receive the following confirmation from the unit **ACM-OFF** confirming the security access mode is switched off and open access mode is activated.

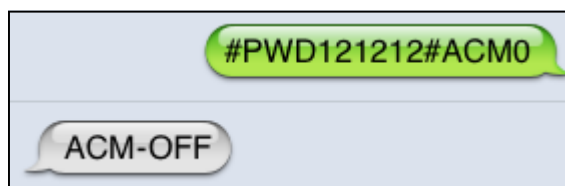

## #GOT Relay ON time

This is the command that allows you to set the relay on times when the unit is called. The maximum time is 65,535 seconds.

To set relay 1 to switch on for 15 minutes each time the unit is called, the following SMS text message is sent to the unit, 1 indicates the relay number and 00900 is the relay on time in seconds, this should be entered in 5 digit format as shown

**#PWD121212#GOT1=00900**

You will receive the following similar confirmation from the unit **GOT1:00900**

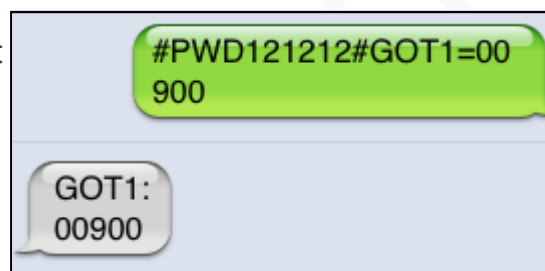

To set relay 2 to switch on for 10 minutes each time the unit is called, the following SMS command is sent to the unit, 2 indicates the relay number and 00600 is the relay on time in seconds, this should be entered in 5 digit format as shown

**#PWD121212#GOT2=00600**

You will receive the following similar confirmation from the unit **GOT2:00600**

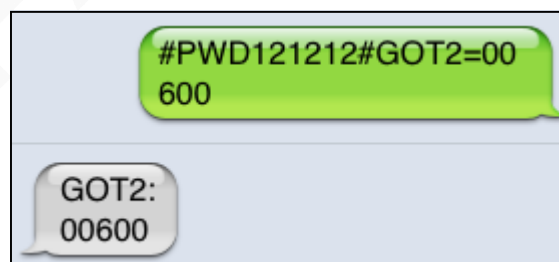

**Note that setting the GOT 1 & 2 time to 00000 will prevent the relays activating when the unit is called.**

## #GOTS

This command allows you to set a delay time before relay 2 switches on after receiving a call. To set the delay time to 5 seconds, you send the following command by SMS text message to the unit. Where 00005 is the delay time in seconds and should be entered in 5 digit format as shown

**#PWD123456#GOTS=00005**

You will receive the following similar confirmation from the unit **GOTS:00005**

**Note that setting GOTS to 00000 will prevent relay 2 switching on.**

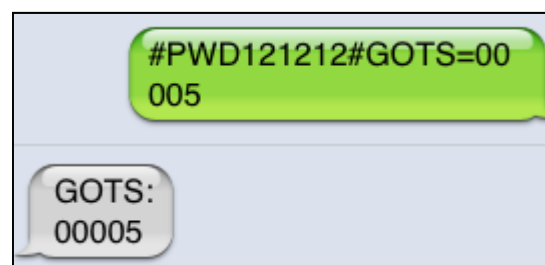

## #GOT Relay ON time—continued

### #GOT?

To check the relay on and delay times you would send the following S.M.S text message to the unit **#PWD121212#GOT?**

You will receive the following similar confirmation from the unit.

**GOT1: 00900**

**GOT2: 00600**

**GOTS: 00005**

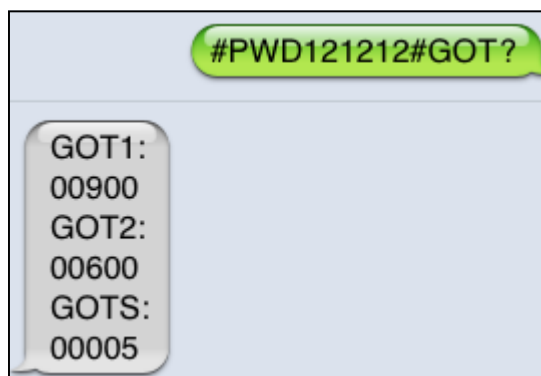

### #RLY

#### Temporary switching on the relays

This command allows you to switch on the relays for up to 65,000 seconds and receive confirmation SMS text messages when the relays switch on and off

**This command does not affect the #GOT1 or #GOT2 settings**

**Note: Confirmation text messages are only sent to telephone numbers in the Administrators list**

To activate relay 1 for 60 seconds you would send the following SMS text message to the unit, where 1 indicates the relay number and 00060 is the on time in seconds, this should be entered in a 5 digit format as shown

**#PWD121212#RLY1=00060**

You will receive the following confirmation text message from the unit **RLY1=00060** when the relay switches on and you will receive the following message when the relay switches off **RELY1-OFF**

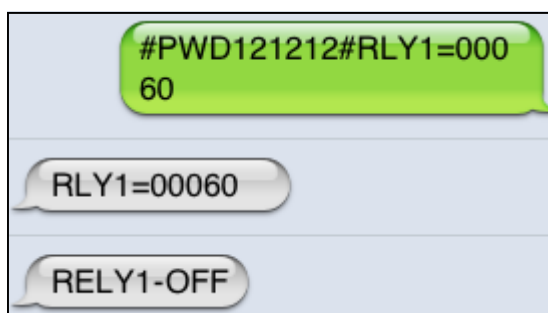

To switch on relay 2 for 5 seconds you would send the following SMS text message to the unit, where 2 indicates the relay number and 03600 is the on time in seconds, this should be entered in a 5 digit format as shown

**#PWD121212#RLY2=00005**

You will receive the following confirmation from the unit **RLY2=00005** when relay 2 switches on and the following confirmation when the relay switches off **RELY2-OFF**

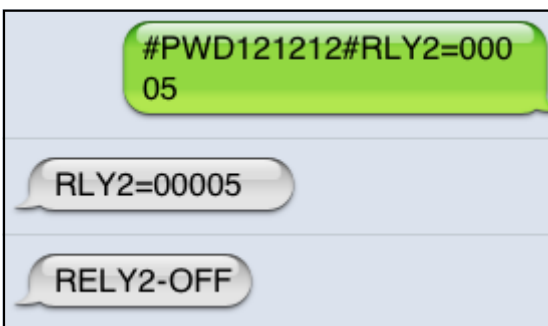

## #RLOP

### Switching the relays on and off

This command allows you to switch the relays on and off and receive confirmation SMS text messages.

**This command does not affect the #GOT1 or #GOT2 settings**

**Note: Confirmation text messages are only sent to telephone numbers in the Administrators list**

To switch Relay 1 on you would send the following SMS text message to the unit.

**#PWD121212#RLOP1=1**

You will receive the following confirmation from the unit **RLOP1=ON**

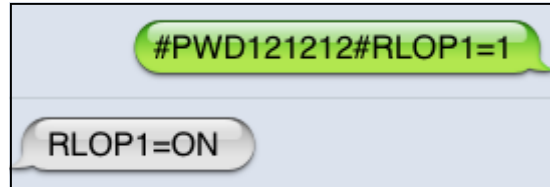

To switch Relay 1 off you would send the following SMS text message to the unit.

**#PWD121212#RLOP1=0**

You will receive the following confirmation from the unit **RLOP1=OFF** followed by **RELY1-OFF**



To switch relay 2 on and off use the commands **#RLOP2=1** and **#RLOP2=0**

If you receive a **RLOP1 Busy** message the relay is already active via a previous command.

## #RLY?

### Checking the status of the relays

To check the status of the relays you would send the following SMS text message to the unit

**#PWD121212#RLY?**

You will receive the following similar confirmation from the unit

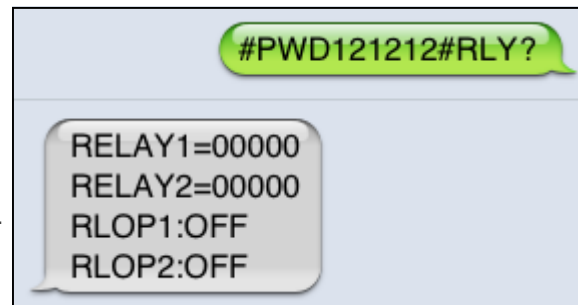

**RELAY1=00000**

**RELAY2=00000**

**RLOP1:OFF**

**RLOP2:OFF**

## \*REST#

### Resetting the unit

To reset the unit to the default settings you would send the following S.M.S text message to the unit

**\*REST#121212** Note that the password prefix is not required

You will receive the following confirmation from the unit **REST-OK** the unit has been reset to the default settings and the password will revert to 123456

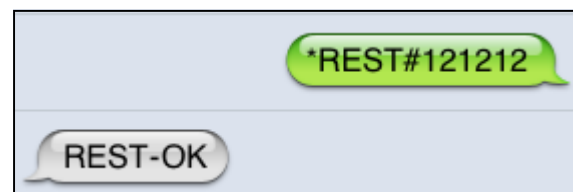

## Programming commands—Quick reference

FUNCTION	COMMAND	FORMAT	NOTE
Changing the Password	<b>#CAP</b>	<b>#PWD123456#CAPxxxxxx#CAPxxxxxx</b>	Default 123456
Check signal strength	<b>#CSQ</b>	<b>#PWD123456#CSQ?</b>	0 – 31, must be >5
Administrator list	<b>#TEL</b>	<b>#PWD123456#TEL1=01827829595</b> Position > telephone number	Up to 8 numbers & 16 digits
Administrator list status	<b>#RERN</b>	<b>#PWD123456#RERN1000000</b> Position > 1 = enabled, 0 = disabled	Administrators who will receive text messages
White list	<b>#WHL</b>	<b>#PWD123456#WHL001=27829595</b> Position > telephone number—last 8 digits	Up to 500 telephone numbers
Security access mode	<b>#ACM</b>	<b>#PWD123456#ACM2</b> <b>#PWD123456#ACM0</b> On > Off	
Relay on time	<b>#GOT</b>	<b>#PWD123456#GOT1=00900</b> time in seconds, 5 digits	Maximum 65,535 sec-
Delay time between relay 1 and relay 2 switching on	<b>#GOTS</b>	<b>#PWD123456#GOTS=00005</b> time in seconds, 5 digits	00000 prevents relay 2 switching on
Temporary switching on relays	<b>#RLY</b>	<b>#PWD123456#RLY1=00060</b> 1=RLY1, 2= RLY2 > time in seconds, 5 digits	Maximum 65,000 seconds
Switching relay 1 and 2 on or off	<b>#RLOP</b>	<b>#PWD123456#RLOP1=1</b> 1=RLY1, 2=RLY2 > 1=ON, 0=OFF	
Resetting the unit	<b>*REST#</b>	<b>*REST#123456</b> Reset to default settings including password	Password prefix not required

## Programming examples

### Controlling a heating system

The simplest way is to wire terminals 7 and 8 on the GSM-AUTO to the terminals on your heating programmer that switch it on. When away from home set the heating programmer to off. You can program the unit to switch on the heating for say 2 hours when you call it.

Add the telephone numbers that you want to use to activate the unit.

To add the number 07827829595 to the white list in position 1, you would send the following SMS text message to the unit. Note only enter the last 8 digits as shown.

**#PWD123456#WHL001=27829595**

Repeat for all the numbers you wish to add incrementing the WHL position by one for each number, WHL002=, WHL003= and so on.

Switch on the security access mode so only the numbers in the white list can activate the unit.

**#PWD123456#ACM2**

Set the relay on time to 2 hours.

**#PWD123456#GOT1=07200**

### Controlling an automatic electric gate

Wire terminals 7 and 8 on the GSM-AUTO to the 'start' push button terminals of the gate control panel.

Follow steps 1 and 2 above.

Set the relay activation time to 1 second.

**#PWD123456#GOT1=00001**

Do not use the gate control panels auxiliary power supply to power the GSM-AUTO, use a separate power supply.

### Ad hoc control of any device using only text messages

Switch on the security access mode, do not enter any numbers in the white list.

**#PWD123456#ACM2**

Add your telephone number to the Administrator list.

**#PWD123456#TEL1=01827829595**

Enable your telephone number to receive confirmation text messages

**#PWD123456#RERN10000000**

Switch on the relays for a set amount of time (60 seconds in the example)

**#PWD123456#RLY1=00060**

1=RLY1, 2= RLY2 > time in seconds, 5 digits

Switch the relays on or off (Relay 1 switched on in the example)

**#PWD123456#RLOP1=1**

1=RLY1, 2=RLY2 > 1=ON, 0=OFF

## Troubleshooting

<p>1. Red power LED not alight</p>	<p>Ensure that your DC power supply is connected correctly, positive (+) to terminal 1 and negative (-) to terminal 2. Verify 12 volts is present using a volt meter</p>
<p>2. Blue network LED flashing every one second and not every 3 seconds</p>	<p>Ensure your SIM card has been activated and that the PIN request has been disabled. If the unit is in a low signal strength area consider using an external GSM antenna or changing to another network provider</p>
<p>3. I am not receiving confirmation test messages when using the #RLY or #RLOP commands</p>	<p>Ensure your telephone number is in the Administrator list and that sending text messages to your number is enabled. See <b>#TEL</b> and <b>#RERN</b> commands</p>
<p>4. I am not receiving any text messages when initially programming the unit</p>	<p>Ensure the unit is connected to the GSM network by observing the blue network LED, it should be flashing once every 3 seconds (see 2 above) Ensure the SIM card has credit</p>
<p>5. When I switch on the relays using the #RLY or #RLOP commands and the unit is called the relays are deactivated</p>	<p>This is the way the unit operates, switch on the security access mode <b>#ACM2</b> so only numbers in the white list can activate the unit</p>
<p>6. The unit occasionally activates by itself</p>	<p>Network operators often make marketing calls to their subscribers, switch on the security access mode <b>#ACM2</b> so only numbers in the white list can activate the unit</p>
<p>7. The unit has been working for several months and has now stopped responding to calls and text commands</p>	<p>Most but not all PAYG SIM cards will be de-activated by the network if not used to make an outgoing voice call or send an SMS text message within a specific period. To prevent this simply send the GSM-AUTO a txt command, it will reply by text message, do this once a month to keep the SIM card active</p>
<p>8. When I call the unit I do not receive a confirmation text message</p>	<p>The unit only sends relay status messages in response to the #RLOP and #RLY commands</p>